

www.ersatzteil-service.de

www.ersatzteilplan.de

Modello n.
IB-5376F

Serie dal n.
001

Stampato n. P5090170

IBEA

LISTA RICAMBI

SPARE PARTS LIST

ERSATZTEILLISTE

LISTE DES PIECES DE RECHANGE



530 MULCHING

[Ihr Ersatzteilspezialist im Internet](#)

REF. N°	PART. N°	QTY	DESCRIZIONE	DESCRIPTION	DESCRIPTION	BESCHREIBUNG
1	P5140573	1	DECALCO	DECAL	MARQUAGE	AUFKLEBER
2	P5140574	1	DECALCO	DECAL	MARQUAGE	AUFKLEBER
3	P5140337	1	DECALCO	DECAL	MARQUAGE	AUFKLEBER
4	P5140538	1	DECALCO	DECAL	MARQUAGE	AUFKLEBER
5	P5140531	1	DECALCO	DECAL	MARQUAGE	AUFKLEBER
6	P5140552	1	DECALCO	DECAL	MARQUAGE	AUFKLEBER
7	P5140550	1	DECALCO	DECAL	MARQUAGE	AUFKLEBER
*	P5110008	1	CHIAVE	KEY	CLEF	SCHLÜSSEL
*	P5090172	1	MANUALE ISTRUZIONI	INSTRUCTION MANUAL	MODE D'EMPLOI	BEDIENUNGSANLEITUNG

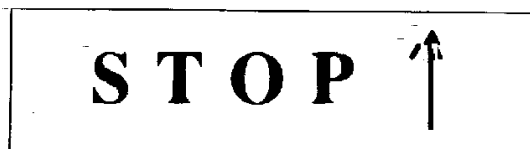

1

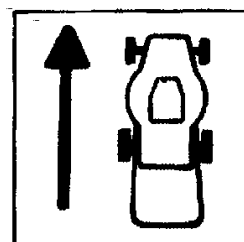

2



3



4

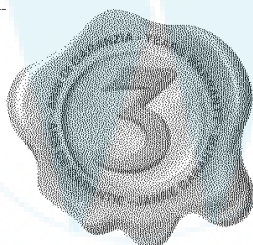

5



6



7

IBEA S.p.A.

Via De Gasperi, 5 - 22070 LUISAGO (CO)

Tel.: 031/92.91.50 - Telex: 380870

Telefax: 031/92.94.07-88.99.85

Ihr Ersatzteilspezialist im Internet

REF. N°	PART. N°	QTY	DESCRIZIONE	DESCRIPTION	DESCRIPTION	BESCHREIBUNG
1			MOTORE	ENGINE	MOTEUR	MOTOR
2	P1050011	3	DADO	NUT	ÉCROU	MUTTER
3	P02068449		STEGOLA INF.	LOWER HANDLEBAR	GUIDON INF.	HOLMUNTERTEIL
4	1010026A1	2	VITE	SCREW	VIS	SCHRAUBE
5	2020050A1	2	GALLETTO	KNOB	POIGNÉE	MUTTER
6	P1010134	2	VITE x B&S QUANTUM	SCREW x B&S QUANTUM	VIS x B&S QUANTUM	SCHRAUBE x B&S QUANTUM
6	P1010135	1	VITE x B&S QUANTUM	SCREW x B&S QUANTUM	VIS x B&S QUANTUM	SCHRAUBE x B&S QUANTUM
6	1010027A1	3	VITE x B&S 2 T.	SCREW x B&S 2 T.	VIS x B&S 2 T.	SCHRAUBE x B&S 2 T.
7	P00046749		LEVA REGOLAZIONE	LEVER	LEVIER	HEBEL
8	P01031649	1	PIASTRA	PLATE	PLAQUE	PLATTE
9	P3040145	1	DISTANZIALE	SPACER	DOUILLE	ABSTANDSSTÜCK
10	P1060006	2	STARLOCK	STARLOCK	STARLOCK	STARLOCK
11	P1010134	1	VITE	SCREW	VIS	SCHRAUBE
12	P2020062	2	COPRIMOZZO	COVER	COUVERCLE	DECKEL
13	1010018A1	2	VITE PER RUOTA	WHEEL SCREW	VIS POUR ROUE	RADSCHRAUBE
14	1020007A1	2	RONDELLA	WASHER	RONDELLE	SCHEIBE
15	P2020083	2	COPERTONE	TYRE	PNEU	REIFEN
16	P2020082	2	CERCHIO	WHEEL HUB	JANTE	FELGE
17	P3030013	4	CUSCINETTO	BEARING	PALIER	LAGER
18	P2020128	2	COPRIRUOTA	WHEEL COVER	PROTECTION	ABDECKUNG
19	P00015176	2	RUOTA COMPL.	WHEEL ASSY.	ROUE COMPL.	RAD KOMPL.
20	P2020088	2	DISTANZIALE	SPACER	DOUILLE	ABSTANDSSTÜCK
21	P1020050	2	RONDELLA ELASTICA	SPRING WASHER	RONDELLE ELAST.	FEDERSCHEIBE
22	P00030047	1	ASSALE POST. COMPL.	REAR AXLE ASS. Y	ESSIEU POST. COMPL.	ACHSE KOMPL.
23	P3040179	1	DISTANZIALE	SPACER	DOUILLE	ABSTANDSSTÜCK
24	P1050011	1	DADO	NUT	ÉCROU	MUTTER
25	P3020021	1	MOLLA	SPRING	RESSORT	FEDER
26	P01028149	1	ASTA	SHAFT	ARBRE	ACHSE
27	P1050011	3	DADO	NUT	ÉCROU	MUTTER
28	P01031749	1	PIASTRA	PLATE	PLAQUE	PLATTE
29	P4050023	1	LAMA	BLADE	COUTEAU	MESSER
30	P1010128		VITE LAMA	BLADE SCREW	VIS DE COUTEAU	MESSERSCHRAUBE
31	1020015A1		RONDELLA ELASTICA	SPRING WASHER	RONDELLE ELAST.	FEDERSCHEIBE
32	1110002A1		MOLLA	SPRING	RESSORT	FEDER
33	P3040104		BUSSOLA LAMA	BLADE BUSHING	DOUILLE DE COUTEAU	MESSERBÜCHSE
34	1090001A1		LINGUETTA	KEY	CLAVETTE	SCHIBENFEDER
35	P2020138		TARGHETTA IBEA	IBEA PLAQUE	IBEA PLAQUE	IBEA AUFKLEBER
36	P02006249		SCOCCA	DECK	CHASSIS	GEHÄUSE
37	P2020144	1	CARTER COPRINCINGHIA	BELT COVER	PROTECTION	ABDECKUNG
38	P1010082	3	VITE	SCREW	VIS	SCHRAUBE
39	P3040184	3	DISTANZIALE	SPACER	DOUILLE	ABSTANSSTÜCK
40	1010003A1	4	VITE	SCREW	VIS	SCHRAUBE
41	P1010119	4	VITE	SCREW	VIS	SCHRAUBE
42	P1010092	2	VITE	SCREW	VIS	SCHRAUBE
43	P4010097	1	FLANGIA	FLANGE	FLASQUE	FLANSCH
44	P1050011	4	DADO	NUT	ÉCROU	MUTTER
45	P2020165		CAPOTTINA MOTORE	ENGINE COVER	COUVERCLE MOTEUR	MOTORABDECKUNG
46	P1010154	2	VITE CAPOTTINA	SCREW	VIS	SCHRAUBE

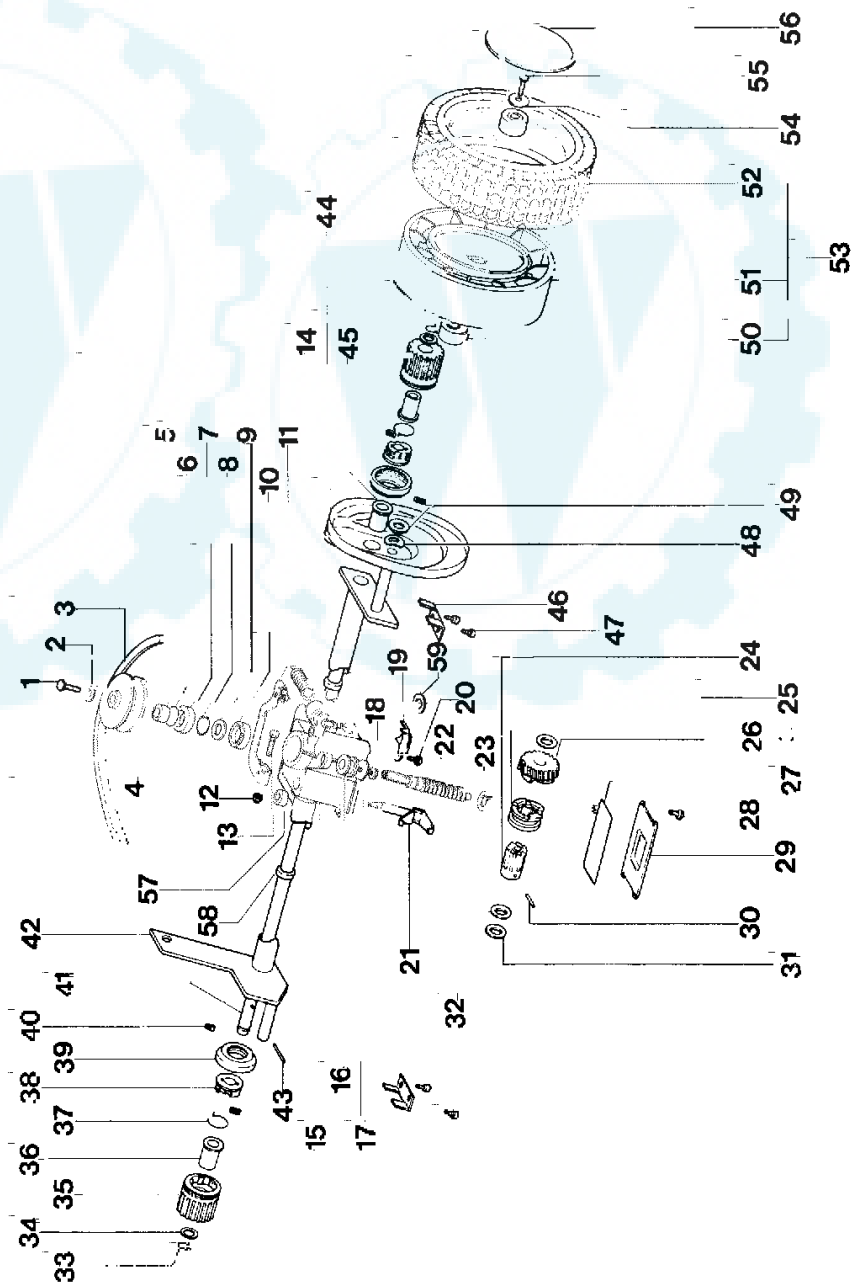
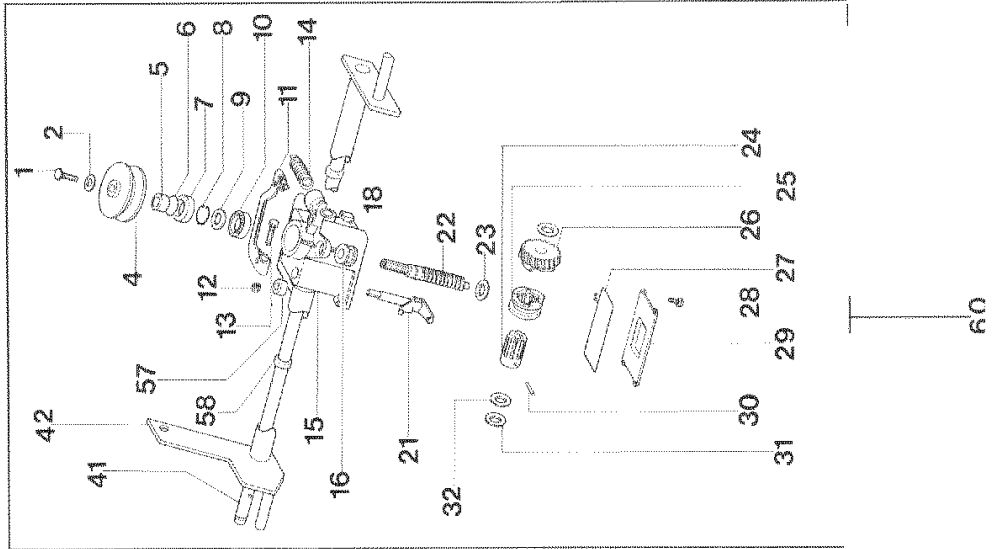

Tav. 2

Vista anteriore e trasmissione
Front axle and gear box
Essieux avant et transmission
Vorderachse und Getriebe

REF. N°	PART. N°	QTY	DESCRIZIONE	DESCRIPTION	DESCRIPTION	BESCHREIBUNG
	1010018A1		VITE	SCREW	VIS	SCHRAUBE
2	1020007A1		RONDELLA	WASHER	RONDELLE	SCHLEIBE
3	P3010019		CINGHIA TRASMISSIONE	TRANSMISSION BELT	COUROIRO DE TRANSMISSION	RIEMEN
4	P3040048		PULEGGIA	PULLEY	POULIE	RIEMENSCHLEIBE
5	P3040049		DISTANZIALE	SPACER	DOUILLE	ABSTANDSSTÜCK
6	P3170013		O-RING	O-RING	JOINT TORIQUE	GUMMIRING
7	P3170010		PARAOILIO	OIL SEAL	JOINT D'ARBRE	WELLENDICHRING
8	P1070004		SEEGER	CIRCLIP	SEEGER	SEEGER
9	P1020051		SPessore	WASHER	RONDELLE	SCHLEIBE
10	P3030010		CUSCINETTO	BEARING	PALIER	LAGER
11	P4070011		LEVA	LEVER	LEVIER	HEBEL
12	1050003A1		DADO	NUT	ÉCROU	MUTTER
13	P1010075		VITE	SCREW	VIS	SCHRAUBE
14	P3020010		MOLLA	SPRING	RESSORT	FEDER
15	P00039199		SCATOLA RIDUTTORE	GEAR BOX	BOÎTE DE REDUCTEUR	UNTERSETZUNGSGETRIEBE
16	P2040010		GOMMINO	RUBBER TUBE	TUBE DE PROTECTION	SCHUTZHÜLLE
17	P1020054		RONDELLA	WASHER	RONDELLE	SCHLEIBE
18	P1010073		VITE	SCREW	VIS	SCHRAUBE
19	P4030010		COPERCHIO MOLLA	SPRING COVER	COUVERCLE	FEDERHALTER
20	P1010076		VITE	SCREW	VIS	SCHRAUBE
21	P3040041		FORCELLA	FORK	FOURCHE	GABEL
22	P3040114		VITE SENZA FINE	WORM GEAR	VIS SANS FIN	SCHNECKE
23	P1020053		SPessore	WASHER	RONDELLE	SCHLEIBE
24	P3050030		BUSSOLA SCANALATA	BUSHING	DOUILLE CANNELÉE	KEILHÜLSE
25	P00037952		INNESTO	SELECTOR COLLAR	MANCHON	SCHALTBÜCHSE
26	P00038252		CORONA	WORM WHEEL	ROUE POUR VIS S. FIN	SCHNECKENRAD
27	P3170014		O-RING	O-RING	JOINT TORIQUE	O-RING
28	P1010076	4	VITE	SCREW	VIS	SCHRAUBE
29	P4110001	1	COPERCHIO SCATOLA	COVER	COUVERCLE	DECKEL
30	P1080007	1	SPINA ELASTICA	CLAMPING SLEEVE	GOUPILLE ELAST.	SPANNHÜLSE
31	1020020A1	2	SPessore	WASHER	RONDELLE	SCHLEIBE
32	P1020051	1	SPessore	WASHER	RONDELLE	SCHLEIBE
33	1070001A1	2	SEEGER	CIRCLIP	SEEGER	SEEGER
34	1020020A1	2	SPessore	WASHER	RONDELLE	SCHLEIBE
35	P3050031	2	PIGNONE	PINION	PIGNON	RITZEL
36	P2020059	2	BUSSOLA	BUSHING	DOUILLE	BÜCHSE
37	P3020012	2	MOLLA	SPRING	RESSORT	FEDER
38	P2100001	2	CRICCHETTO	DRIVER	CLIQUET	MITNEHMER
39	P2020060	2	COPRIPIGNONE	CAGE	CAGE	KÄFIG
40	P2110001	4	SALTARELLO	CAM	CLIQUET	NOCKEN
41	P3040162	1	ALBERO TRASMISSIONE	TRANSMISSION SHAFT	ARBRE DE TRANSMISSION	WELLE
42	P00030345	1	ASSALE ANT.	FRONT AXLE	ESSIEU ANT.	ACHSE
43	P1080004	2	SPINA	PIN	GOUPILLE	STIFT
44	P4030011	2	COPRIRUOTA	WHEEL COVER	PROTECTION	ABDECKUNG
45	P2020070	2	BUSSOLA	BUSHING	DOUILLE	BÜCHSE
46	P01033266	2	SUPPORTO PER ASSALE	SUPPORT AXLE	SUPPORT	HALTER
47	1010012A1	4	VITE	SCREW	VIS	SCHRAUBE
48	P1020050	2	RONDELLA ELASTICA	SPRING WASHER	RONDELLE ELAST.	FEDERSCHLEIBE
49	P2020088	2	DISTANZIALE	SPACER	DOUILLE	ABSTANDSSTÜCK
50	P3030013	4	CUSCINETTO	BEARING	PALIER	LAGER
51	P2020084	2	CERCHIO	WHEEL HUB	JANTE	FELGE
52	P2020083	2	COPERTONE	TYRE	PNEU	REIFEN
53	P00015276	2	RUOTA COMPL.	WHEEL ASSY.	ROUE COMPL.	RAD KOMPL.
54	1020007A1	2	RONDELLA	WASHER	RONDELLE	SCHLEIBE
55	1010018A1	2	VITE	SCREW	VIS	SCHRAUBE
56	P2020062	2	COPRIMOZZO	COVER	COUVERCLE	DECKEL
57	P3170012	1	PARAOILIO	OIL SEAL	JOINT D'ARBRE	WELLENDICHRING
58	P3170011	2	PARAOILIO	OIL SEAL	JOINT D'ARBRE	WELLENDICHRING
59	P1020065	1	RONDELLA	WASHER	RONDELLE	SCHLEIBE
60	P00078645	1	SCATOLA RIDUT. COMPL.	GEAR BOX ASS.Y	REDUCTEUR COMPL.	GETRIEBE KOMP.

Tav. 3

Stegola superiore e comandi
Upper handle and controls
Guidon supérieur et éléments de commande
Lenkeroberteil und Bedienungselemente

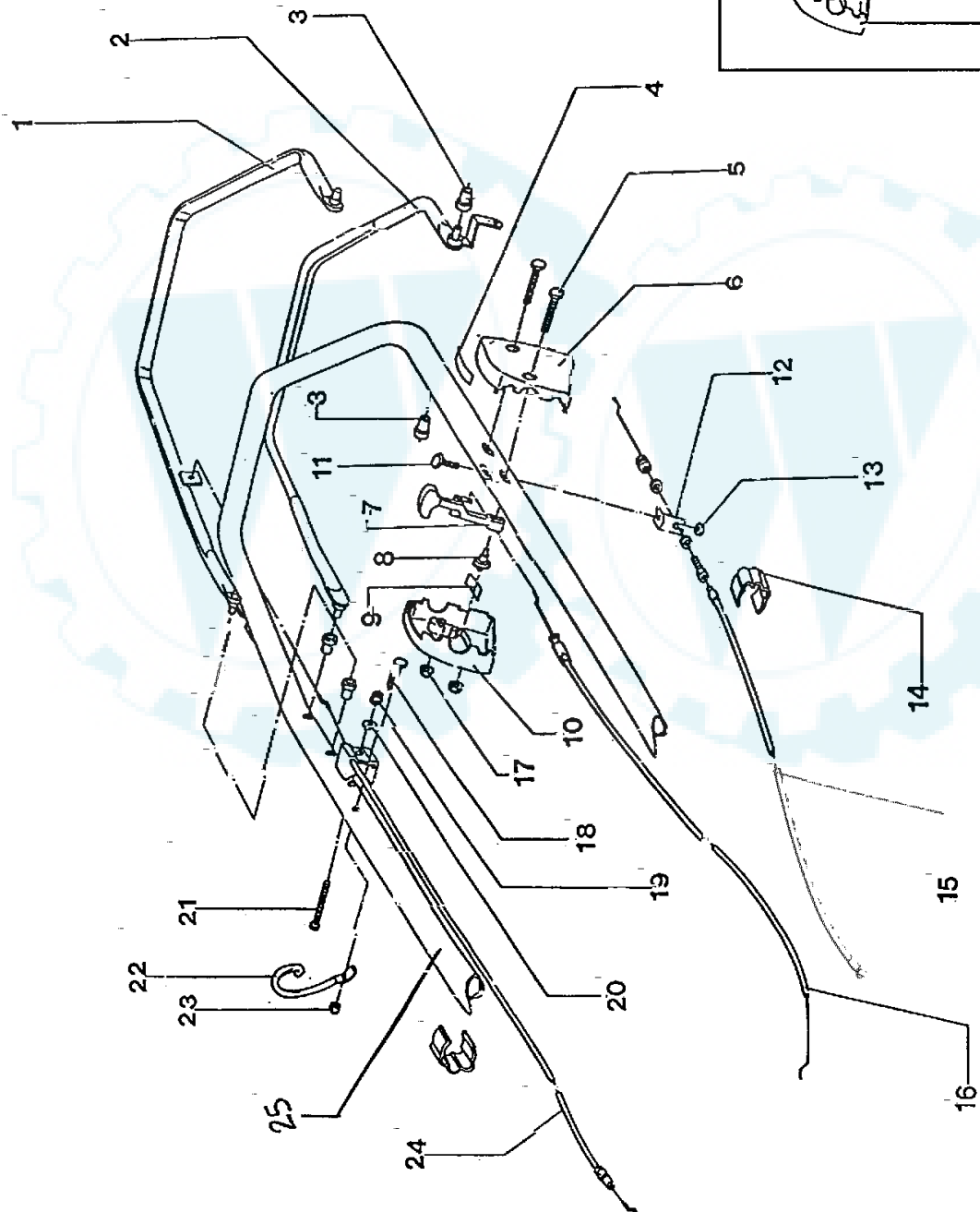
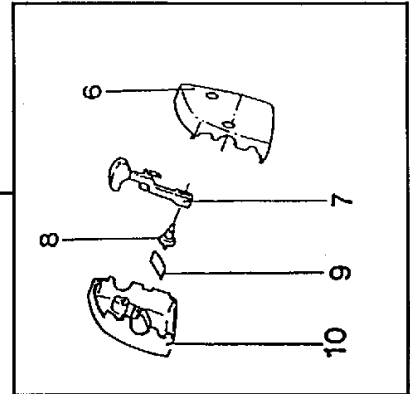

www.ersatzteil-service.de

www.ersatzteilplan.de

REF. N°	PART. N°	QTY	DESCRIZIONE	DESCRIPTION	DESCRIPTION	BESCHREIBUNG
	P480038VE	1	MANIGLIA SYSTEM 2	SYSTEM 2 LEVER	LEVIER SYSTEM 2	SYSTEM 2 HEBEL
2	P020421B1	1	MANIGLIA TRAZIONE	TRACTION LEVER	POIGNÉE DE TRACTION	ANTRIEBSHEBEL
3	P2020153	4	BUSSOLA	BUSHING	DOUILLE	BÜCHSE
4	P5140552	1	DECALCO	DECAL	MARQUAGE	AUFKLEBER
5	P1010102	2	VITE	SCREW	VIS	SCHRAUBE
6	P2020107	1	SCATOLA ACC. SX	L.H. HOUSING	BOÎTE GAUCHE	SCHALE L.
7	P00065099	1	LEVA ACCELERATORE	THROTTLE LEVER	LEVIER DE COMMANDE	GASHEBEL
8	P2020108	1	NOITOLINO	BOLT	BOULON	STIFT
9	P4010059	2	MOLLA	SPRING	RESSORT	FEDER
10	P2020106	1	SCATOLA ACC. DX	R.H. HOUSING	BOÎTE DROITE	SCHALE R.
11	P1010078	1	VITE	SCREW	VIS	SCHRAUBE
12	P4010060	1	FERMO	PLATE	PLAQUE	PLATTE
13	1050003A1	1	DADO	NUT	ÉCROU	MUTTER
14	P2020080	2	FERMA CAVO	CLIP	CLIP	HALTER
15	P5010025	1	CAVO TRAZIONE	TRACTION CABLE	CÂBLE DE TRACTION	ANTRIEBSKABEL
16	P5020038	1	CAVO ACCELERATORE	THROTTLE CABLE	CÂBLE DE GAZ	GASKABEL
17	1050003A1	2	DADO	NUT	ÉCROU	MUTTER
18	P1010065	1	VITE	SCREW	VIS	SCHRAUBE
19	1050003A1	1	DADO	NUT	ÉCROU	MUTTER
20	1020013A1	1	RONDELLA	WASHER	RONDELLE	SCHEIBE
21	P1010203	1	VITE	SCREW	VIS	SCHRAUBE
22	P01068343	1	SUPPORTO A RICCIOLO	STARTER HOLDER	SUPPORT	HALTER
23	1050002A1	1	DADO	NUT	ÉCROU	MUTTER
24	P5010059	1	CAVO SYSTEM 2	SYSTEM 2 CABLE	CÂBLE SYSTEM 2	SYSTEM 2 KABEL
25	P3120104VE	1	STEGOLA SUPERIORE	UPPER HANDLE	GUIDON SUPERIEUR	OB. FÜHRUNGSHOLM
26	P00035099	1	SCATOLA ACC.COMPL.	THROTTLE HOUSING ASS.Y	BOÎTE DE GAZ COMPL.	GASGEHÄUSE KOMPL.



Ihr Ersatzteilspezialist im Internet

Tav. 1

Vista generale
Complete machine
Vue d'ensemble
Gesamtansicht

